

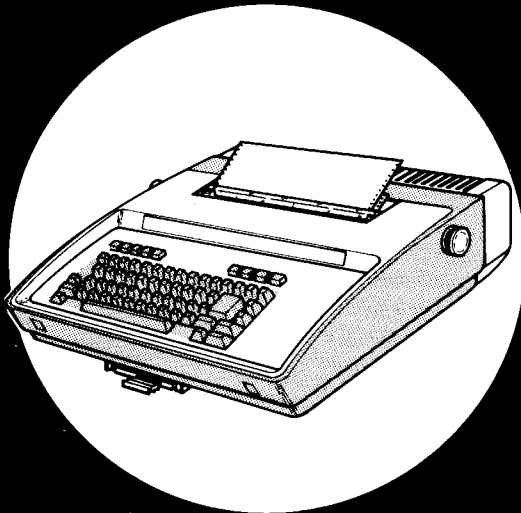

TELETYPE
CORPORATION



HOW TO OPERATE

the **43** teleprinter

BASIC KSR

"Warning: This equipment generates, uses, and can radiate radio frequency energy and if not installed and used in accordance with the instructions manual, may cause interference to radio communications. It has been tested and found to comply with the limits for a Class A computing device pursuant to Subpart J of Part 15 of the FCC Rules, which are designed to provide reasonable protection against such interference when operated in a commercial environment. Operation of this equipment in a residential area is likely to cause interference in which case the user at his own expense will be required to take whatever measures may be required to correct the interference.

IL100

TABLE OF CONTENTS

HOW TO OPERATE INSTRUCTIONS

Introduction	1
Connections and Power Turn On.	2
Operational Controls and Status Indicators.	3
Keyboard Layout	4
Establishing Communications With Distant Terminals	5
Keyboard-Printer Operation	7
Teleprinter Supplies Maintenance	8
Installing Paper (Sprocket Feed)	9
Installing Paper (Tractor Feed)	10
Installing Paper (Friction Feed).	12
Installing Ribbon.	13

SUPPLEMENTARY OPERATIONAL INFORMATION

Local Talk Mode Key	14
Data Mode Key	15
Automatic Answer Mode Key	17
Transfer to Talk	19
Disconnecting Calls	19
Interrupt and Alarm Keys	20
Printer Test, Parity, Duplex and Character Speed Keys	21
Special Keyboard Characters.	22
Key Telephones and Extensions	23
When Trouble Occurs	24

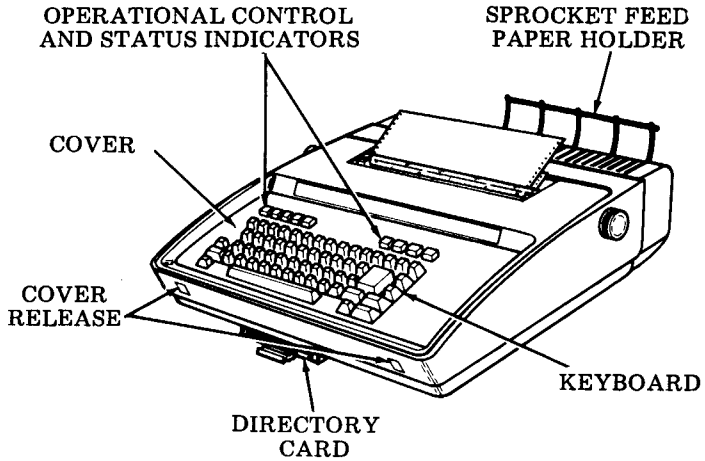

43 KSR Sprocket Feed Teleprinter

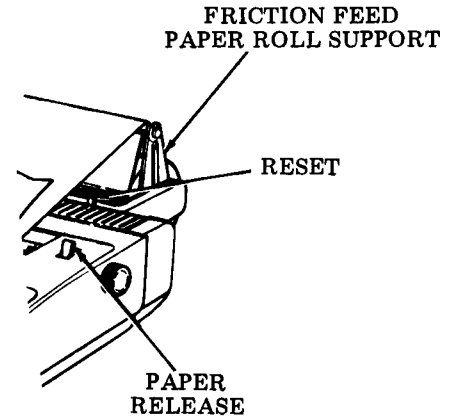

43 KSR Friction Feed Teleprinter

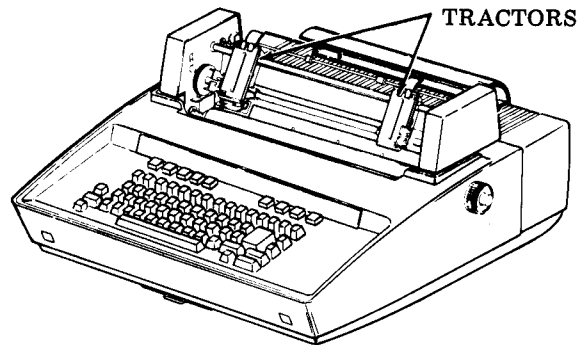

43 KSR Tractor Feed

HOW TO OPERATE INSTRUCTIONS

(Pages 1 Through 13)

INTRODUCTION

The 43 Basic KSR Teleprinter provides character-at-a-time keyboard-printer send-receive operation. Transmission speeds are 10 characters per second (cps) (100 wpm) or 30 cps (300 wpm) and can be selected by the attendant to match the remote station.

The 43 Teleprinter may be connected to an external communications device (modem) which may be associated with a telephone for connections and for transmission of data. A permanent connection via private line may also be used in these arrangements.

When connected directly to an associated modular telephone, calls are originated in a manner similar to regular telephone calls and can be answered either automatically or manually. The telephone can be used for normal voice communication or data messages can be exchanged over the telephone line using controls on the 43 Teleprinter.

In some arrangements the 43 Teleprinter may be connected directly to a computer or remote terminal.

On sprocket feed printers, messages with up to 132 characters per line are printed on 12 inch wide sprocket feed paper. The paper may be fed from a supply box or limited amounts can be placed in a paper holder that can be attached to the rear of the teleprinter. (See Page 8 for paper suppliers.)

On friction feed printers, messages up to 80 characters per line are printed on 8-1/2 inch wide roll type paper. The roll is held in a support attached to the rear of the teleprinter.

The tractor feed printer accepts paper widths from 3-1/2 inches up to 12 inches. Messages up to 80 characters per line may be printed on 12 inch sprocket feed paper.

The ribbon is part of a cartridge that can be readily replaced with the cover open. Replacement ribbon cartridges can be obtained from Teletype Corporation (see Page 8).

A pullout directory card holder under the front of the keyboard may be used to write in frequently used telephone numbers and note any extensions (see Page 24). Exceptions to standard operating features should be recorded on the reverse side of the card.

CONNECTIONS AND POWER TURN ON

- Make sure ac power cord and modular telephone cords or cord to any external communications device are connected as shown before turning on power.

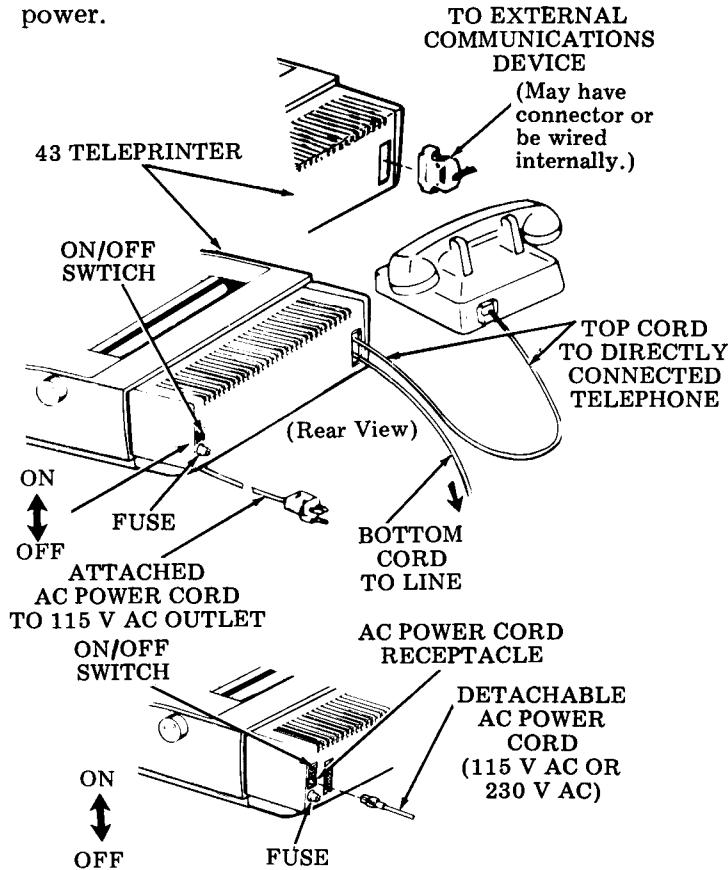

- Turn on power to teleprinter by depressing upper half of ON/OFF switch.
- When power is first turned on, the print head will move fully left and the TERM READY key on the keyboard will light. During normal operation one of the three operational mode control keys should always be lit indicating power is on.

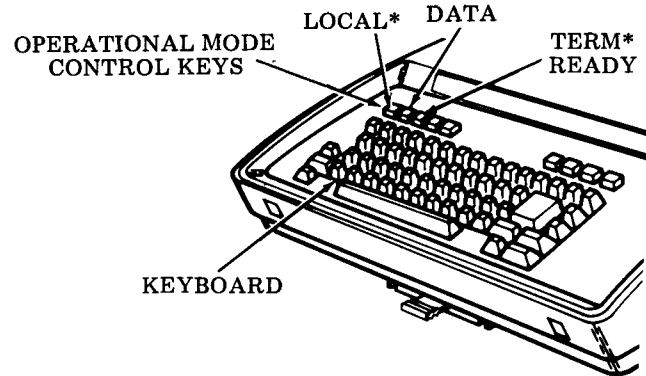

*On sets with a directly connected telephone, the LOCAL and TERM READY keys are marked LOCAL-TALK and AUTO ANSW, respectively.

- Power should normally be left on to automatically answer incoming calls on arrangements so equipped or receive data messages. However, when not in use, the power to the teleprinter may be turned off without affecting the normal use of the telephone. In some applications, turning off power may affect operation of other terminals in the system.

OPERATIONAL CONTROLS AND STATUS INDICATORS

- Use and function of the operational control and status indicators should be reviewed before the 43 Teleprinter is operated locally or on-line.

One of these three keys always lit indicating communications mode and power on. (See Pages 5 or 6 and 14 through 19.)

Use is system dependent. Blinds keyboard when lit. (See Page 20.)

Lights on paper-out or other alarm conditions (See Page 20.)

Independent local test of printer. (See Page 21.)

Use is system dependent. Controls printing of ■ on received parity error. (See Page 21.)

Sends and receives at 30 or 10 characters per second. (See Page 21.)

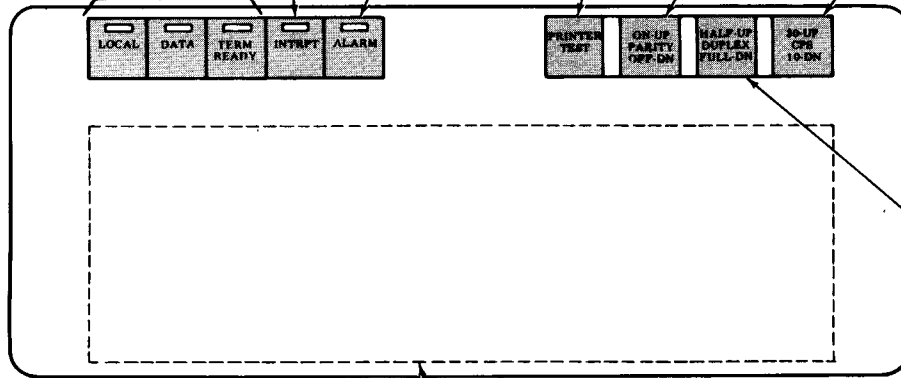

KEYBOARD
(See Pages 4 and 22.)

Controls local printing of transmitted data. (See Page 21.)

Reset for partial roll of paper. (See Page 12.)

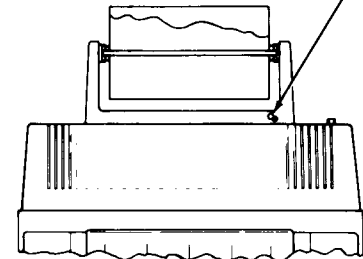

(Top View)

KEYBOARD LAYOUT

- The keyboard is operational locally in the Local mode and on-line in the Data mode.

Locks down for capital alpha. Releases up for lower case (affects alpha characters only).

Shifts lower case alpha to upper case alpha and symbols on lower half of keytop to symbols on upper half. (Does not release CAPS LOCK.)

See Page 22 for the remaining CTRL key generated characters.

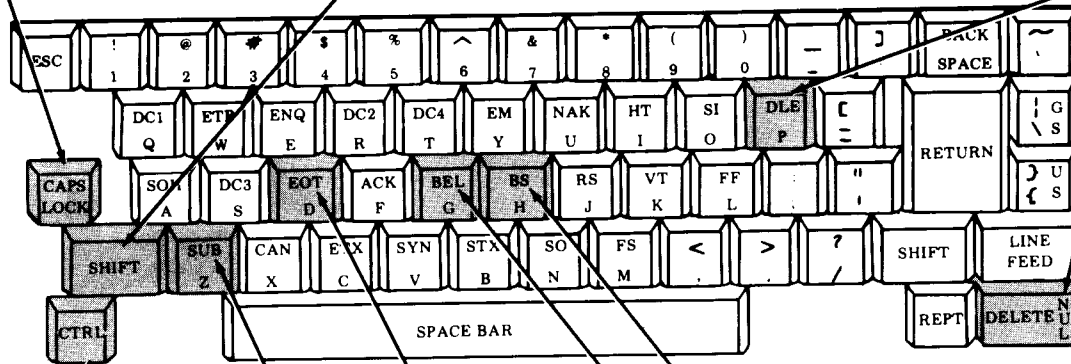

- Several keys perform special functions in addition to sending the code when depressed together with the CTRL key:

EOT — may initiate telephone line disconnect.
SUB — prints ■ .
BEL — sounds bell.
BS — performs backspace in addition to BACKSPACE key.

- Several escape sequence functions also can be performed by depressing the ESC followed by the indicated lower case key. (See Page 22.)

ESC l — (ESC lower case L) set left margin.

ESC r — Set right margin.

ESC x — Clear left and right margin.

ESC m — Releases right margin (and left margin if print head is at left margin).

Procedures for Arrangements Without an Associated Telephone Directly Connected to the Terminal

- Establishing connection and transferring to the Data mode on these arrangements is basically under the control of the directly connected communications device (modem) and its associated telephone over the switched-network or, without a telephone over private lines. In some arrangements terminals are directly connected to the distant terminal or computer. Use of these external devices should be specified locally since many variations are possible, ie, pushbuttons on modem or on phone, exclusion keys, automatic answer, etc.
- The procedures as shown below, that normally apply to operation of the controls of the terminal, should be followed:
 - Before transferring a telephone call to the Data mode (call originated or answered) or to place terminal in a ready condition:
 1. Turn ON ac power (see Page 2).
 2. Clear any alarm condition (paper-out, cover open).
 3. Depress TERM READY key (if not lit). Key should light.
 - Transfer to Data mode
 - The DATA key lights under control of the external device or distant station:
 1. Data can be sent or received on-line only when the DATA key is lit and the LOCAL key is not lit.
 2. On some arrangements the DATA key may light immediately without the TERM READY key being lit.
 - To disconnect a telephone call in DATA mode
 - Calls may be disconnected as follows:
 1. An EOT code is received. (TERM READY key may light.)
 2. The LOCAL key is depressed. (LOCAL key will light.)
 3. Paper-out and eight received line feeds (LOCAL key will light.)
 4. Other log-off procedures, loss of data signals, etc.

Procedures for Arrangements With an Associated Telephone Directly Connected to the Terminal

- Telephone calls must be originated and answered as follows in order to send and receive messages or talk. Calls can also be disconnected as described below. Power must be on to complete a data call (see Page 2).

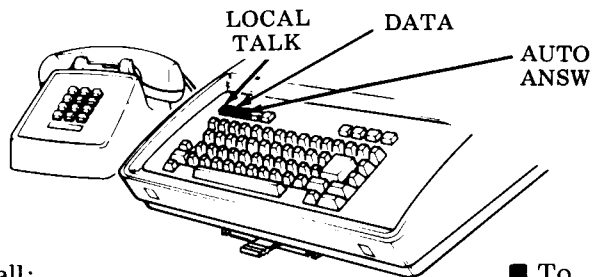

■ To Originate a Call:

1. LOCAL TALK key lit. Depress if not lit. Dial in normal manner. (If dial tone is not heard, hang up momentarily.)
2. Listen for Data tone or talk:
 - If tone is heard, transfer to Data.
 - If no tone is heard, talk, then transfer to Data when agreed.
3. Transfer to Data mode by depressing DATA key and hang up. Key lights (may flash before lighting).
4. Data transmission may begin.

■ To Answer a Call With AUTO ANSW Key Lit: (May be depressed to light.)

1. No action required. Phone rings once. DATA key lights and AUTO ANSW key extinguishes.
2. Data transmission may begin.

■ To Answer a Call With LOCAL TALK Key Lit: (Depress if not lit.)

1. When phone rings lift handset and talk.
2. When agreed, transfer to data by depressing DATA key and hang up.
3. Key lights (may flash before lighting).
4. Data transmission may begin.

■ To Disconnect a Call:

1. In Data mode:
 - Depress the LOCAL TALK key or:
 - Send EOT or other log-off procedures or:
 - Transfer to Automatic Answer mode.
2. In Local Talk mode:
 - Hang up handset.

Note: Call may also disconnect from remote signals, such as received EOT. See the backside of the directory card for any exception to this feature, Option 433b.

KEYBOARD-PRINTER OPERATION

●The keyboard-printer can be operated locally with the LOCAL or LOCAL-TALK key lit or on-line with the DATA key lit.

●Signal Bell

The signal bell sounds when characters are entered seven characters before and at the right margin, ie, margin at 80, bell at 73 and 80. Also sounds at left margin when attempting to backspace and when an interrupt is sent.

●Local Return Line Feed

The carriage is returned and the paper advances one line when the CTRL RETURN keys are operated together. No character is sent on-line.

●Printer

The printer copies all printable data messages except that in full duplex (Data mode only) the printer copies received data only.

●Margin Setting

When power is turned on, the left- and right-hand printing margins are reset to 1 and 132 on sprocket feed or 1 and 80 on friction feed and tractor feed. They may be set or cleared locally or on-line by using the escape sequences. See Page 4. To change either margin outward, both must be reset.

●Indicator Scale

The next printing location of the print head and the position for setting left- and right-hand margins is indicated by the print head marker at the print indicator scale. The print head moves back when printing resumes after 1 second delay.

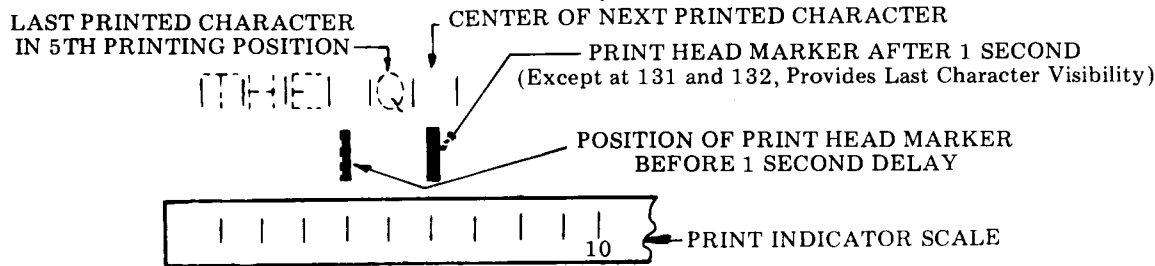

TELEPRINTER SUPPLIES AND MAINTENANCE

Ribbon

The ribbon cartridges provided by Teletype Corporation utilize ribbon material chosen for its physical stability and nonabrasive inks which have a lubricating quality. The use of ribbon cartridges without these required properties may reduce print head performance and life in addition to shorter ribbon life.

The ribbon cartridge should be replaced whenever the ribbon becomes frayed or print density becomes light. Ribbons obtained from Teletype Corporation should produce 5 million legible printed characters.

The Teletype Corporation part number for a package of six ribbon cartridges is TP430484 and can be ordered from Teletype Corporation, using the order form furnished with each terminal.

Sprocket Feed Paper

Paper for the 43 Sprocket Feed Teleprinter must be 12 inch sprocket feed, while tractor feed paper may be from 3 inch to 12 inch sprocket feed. Both teleprinters require paper with folds or horizontal perforations located midway between sprocket holes and standard sprocket hole size and spacing. This paper may be single-ply with 8-1/2 inch folds to provide 11 inch x 8-1/2 inch copy when the 1/2 inch wide

sprocket hole strip is removed at the edge serrations. (Characters are printed to within 7/8 inch of the left and right paper edge before the strips are removed.) Similar replacement paper may be obtained from the supplier listed on the original paper box or from other suppliers listed below or in the telephone book yellow pages.

Other types of sprocket feed paper with different form lengths, lighter weight, no edge serrations or additional copies, etc, may also be used. Multicopy forms consisting of the original and 2 copies of 12 pound basic paper (using 8 pound basic carbon paper) produce clear copy. Acceptable copy may also be obtained on variations of multicopy forms using different weight paper or carbonless paper, however all paper or forms should be tried before ordering large quantities. Crimped multiple part forms are not recommended and stapled forms are not allowed. Consult your paper supplier for specific needs to assure complete satisfaction.

Friction Feed Paper

Paper for the 43 Friction Feed Teleprinter should be standard 8-1/2 inches wide, single-ply, furnished in 5 inch maximum diameter rolls with a 1 inch diameter spindle hole.

Wallace Business Forms Inc.
444 W. Grand Ave.
Chicago, IL 60610
Cat. No. E-6879

Moore Business Forms, Inc.
1205 N. Milwaukee Ave.
Glenview, IL 60025
Form No. 1280J

Duplex Products Co.
228 W. Page
Sycamore, IL 60178
Cat. No. 1-1280-15P

Installing Paper (Sprocket Feed)

- Install paper as shown after centering the print head and removing the unused paper. It is not necessary to disconnect an on-line call, open the cover or turn off power. However, to avoid loss of data, paper should not be replaced without requesting the remote terminal to stop sending.

Note: Paper may be fed directly from the supply box or if the paper holder is used, a limited stack of forms may be placed in the holder.

- 1 Pull the paper-out sensing lever towards you until it latches. Lift rear edge of paper separator and tilt forward.

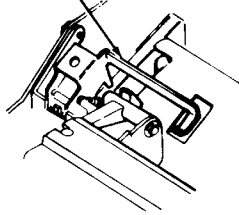

- 2 Fold back first sheet, if desired, and route paper behind the paper separator. Line up sprocket holes on leading edge of both sides of paper with sprocket pins. Insert under rear side of platen. Release paper separator.

PAPER SEPARATOR

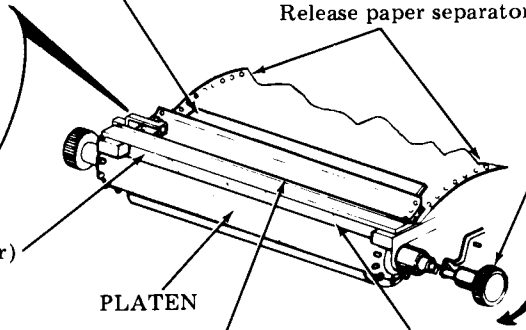

- 3 Advance paper to paper guide using platen knob.

- 4 Lift paper guide (plastic bar) thereby unlatching the paper-out sensing lever.

- 5 Advance paper under the paper guide then close guide. Paper may be fed to desired position using CTRL RETURN keys. (With power off the platen will be free rolling and CTRL RETURN is inoperative.)

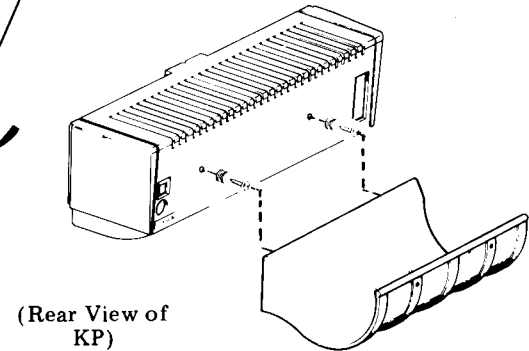

- 6 Depress  key to extinguish ALARM indicator if not off.

Installing Paper (Tractor Feed, Continuous Forms)

To reinstall paper as shown, it is not necessary to disconnect an on-line call, open the cover or turn off power. To avoid loss of data, however, paper should not be replaced without requesting the remote terminal to stop sending. See next page if tractors or paper must be repositioned or to check drag bail roller position.

PAPER DRAG BAIL

TRACTOR LID

PLATEN

Paper path.

PAPER SENSOR

SOFT ROLL
BUTTON

ENGAGED

DISENGAGED

④ Route paper under paper sensor and platen while holding sensor lever down, then pull the paper until it extends beyond tractors.

③ Lift paper drag bail until locked in the raised position.

⑥ To advance paper, use line feed key or rotate platen knob. To slightly reposition the form or a line vertically, use soft roll feature. Depress soft roll button on platen knob and rotate platen knob. Release soft roll button.

⑤ Place the paper feed holes over the tractor pins keeping paper straight in tractor mechanism and close lids. This should cause the paper drag bail to fall into its operating position.

If the paper width is changed or is repositioned horizontally, some or all of the following steps should be taken. With paper partially installed (Steps 1 through 4 on previous page), perform the following as required.

Note: To assure proper operation, the left tractor should be in its fully left position.

- ① Squeeze left tractor release to reposition left tractor. Install paper in tractor and close lid. Paper drag bail will fall into operating position.

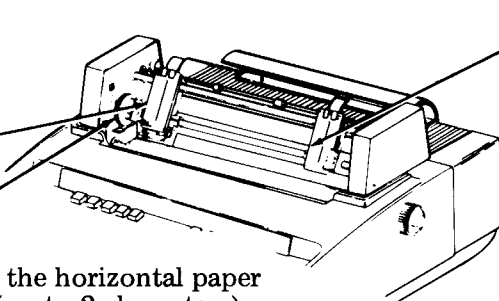

- ② Squeeze the right tractor release with your thumb and forefinger and position the tractor to engage the paper feed holes then close lid. Tractor may require side to side adjustment to hold form flat against the platen.

- ③ To refine the horizontal paper position (up to 2 characters), rotate the thumb wheel.

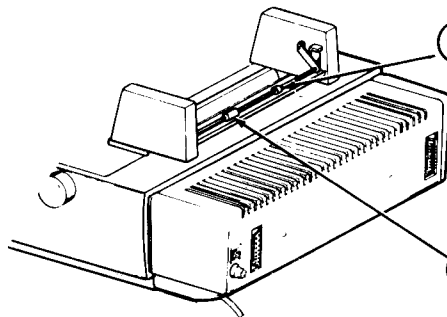

- ④ Position the paper drag bail dark colored plastic roller to approximate center of paper.

- ⑤ Position the light colored metal roller approximately one inch from right edge of paper to equalize the paper drag.

- ⑥ Set right margin (and left margin), if necessary. To reposition form vertically see ⑥ on previous page.

INSTALLING PAPER (Friction Feed)

- Install paper as shown after removing the unused paper from the printer. It is not necessary to turn off power or open the cover when replacing the paper but to avoid loss of data, paper should be replaced after the remote terminal stops sending.

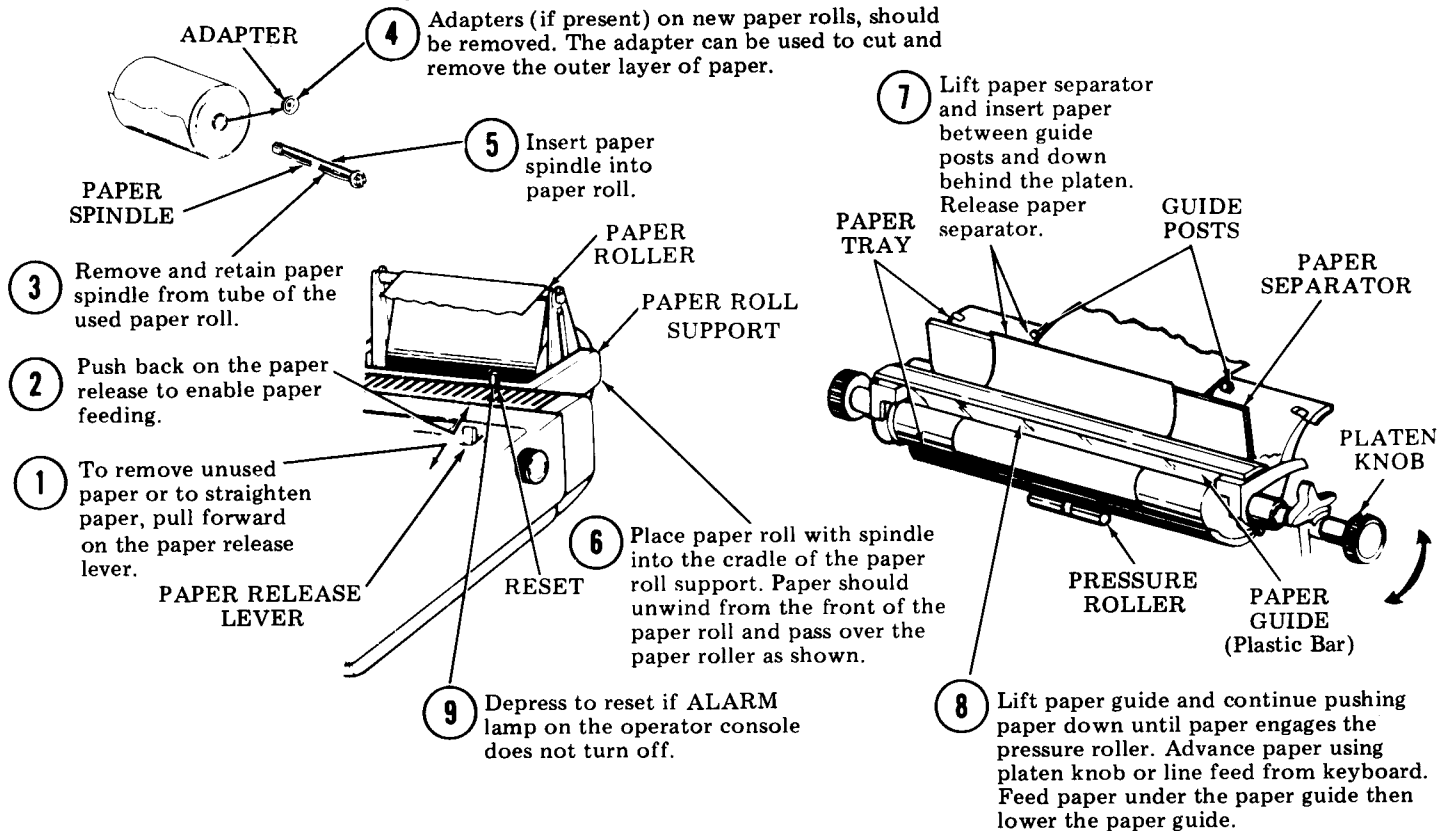

To Install Ribbon

Refer to Ribbon Installation under printer cover.

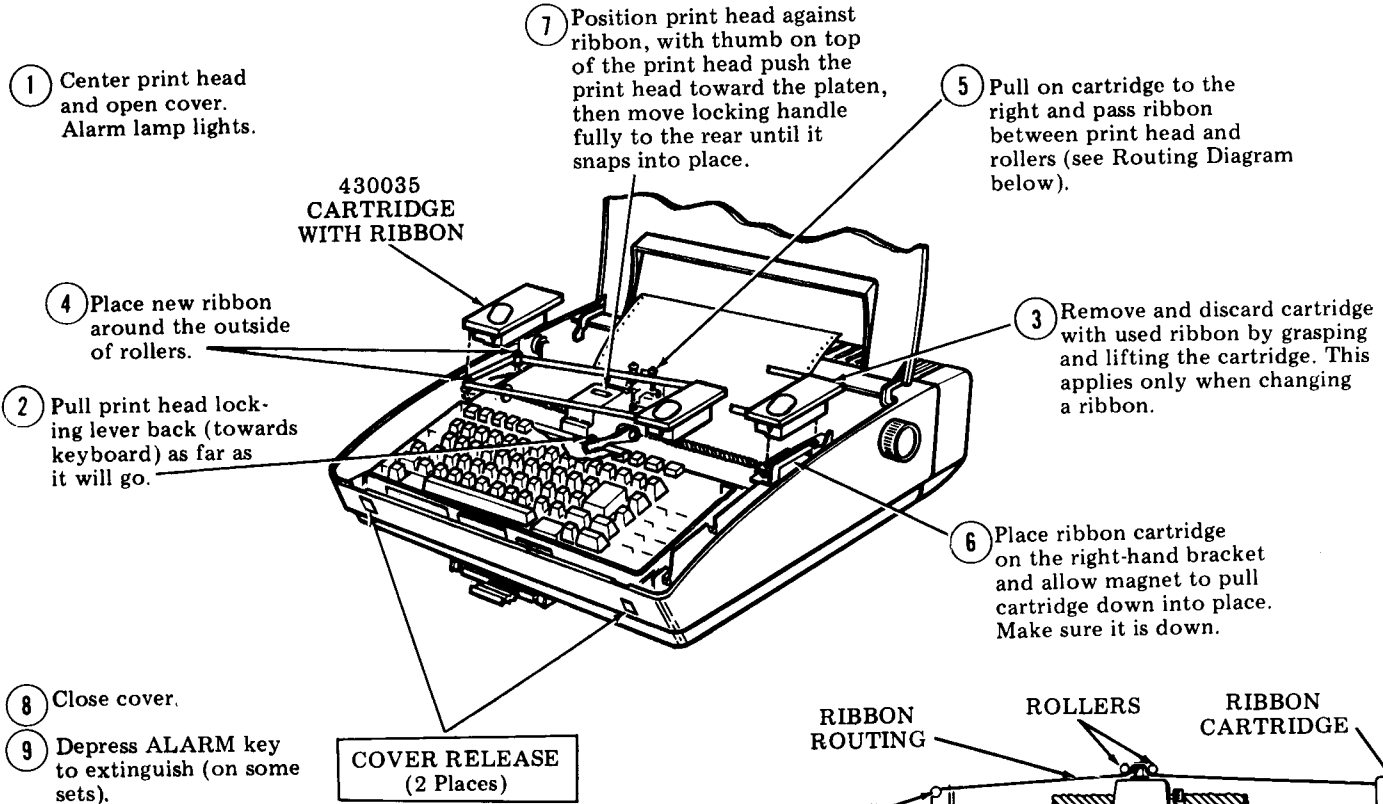

Note: Make sure ribbon is fully on all four rollers before closing cover.

SUPPLEMENTARY OPERATIONAL INFORMATION
(Pages 14 Through 28)

LOCAL TALK MODE KEY

(Arrangements With a Directly Connected Modular Telephone)



Key lights in Local Talk mode.

- The Local Talk mode can be entered:
 - At any time, by momentarily depressing the LOCAL TALK key. Will disconnect call in Data mode.
 - By depressing the PRINTER TEST key. (See Page 19.)
 - Opening the cover or removing paper in the Automatic Answer mode.
 - Receiving eight line feeds in the Data mode after paper-out alarm.
- The telephone is enabled for normal use and the keyboard printer can be operated locally off-line in the Local Talk mode. See Page 6 for telephone and Page 7 for keyboard-printer operation.
- The Local Talk mode can be terminated by:
 - Depressing AUTO ANSW key.
 - Transferring call to Data mode.
 - Turning off power.
- Can be used to clear Loop-Back mode or immediately stop flashing of DATA key when a call is abandoned.

(Arrangements With No Directly Connected Telephone)



Key lights in Local mode.

- The keyboard printer can be operated locally off-line in the Local mode. (Telephones associated with external communications devices may be able to operate regardless of the condition of the LOCAL lamp.)
- The Local Talk mode can be entered:
 - At any time, by momentarily depressing the LOCAL TALK key. This may cause a disconnect.
 - When PRINTER TEST key is operated.
 - Opening the cover or by removing paper in the Automatic Answer mode.
 - Receiving eight line feeds in the Data mode after paper-out alarm.

DATA MODE KEY

(Arrangements With a Directly Connected Modular Telephone)



Key lights in Data and when in Analog Loop-Back.

- Data can be sent or received on-line in the Data mode only.
- The Data mode can be entered:
 - Automatically — following a telephone call or Analog Loop-Back in the Automatic Answer mode.
 - Manually — after a telephone connection has been established in the Local Talk mode by momentarily depressing the DATA key before hanging up.
- The Data mode will be terminated disconnecting the call when:
 - The character EOT (CTRL D on the keyboard) is received.
 - The mode is manually transferred to Automatic Answer (Page 17) or Local Talk (Page 14).
 - Eight line feeds are received after paper-out alarm. (See Page 20.)
- Data signals from the remote station are lost.
- The local printer test is operated (Page 21).
- The call is disconnected for any reason (Page 19).
- Power is turned off.
- The telephone is disabled during the Data mode (cannot ring, dial or talk).
- The DATA key may blink indicating a short interruption in data signals (short flash).
- Transfer to Data cannot be completed if the answering station turned on power after the call was received.

Note: The DATA key flashes during transfer from the Automatic Answer or Local Talk modes. If the transfer is not properly completed within 20 seconds, (ie, local or distant station does not go to Data mode, etc.) the DATA key will stop flashing, the call will disconnect and the AUTO ANSW key will light.

(Arrangements With No Directly Connected Telephone)



Key lights in Data mode.

- With key lit (LOCAL and ALARM lamps not lit) data can be sent and received on-line.
- The Data mode is under control of the external communications device or directly connected distant terminal. (See TERM READY.)
- The DATA key is blocked from operation.

AUTOMATIC ANSWER MODE KEY

(Arrangements With a Directly Connected Modular Telephone)



Key lights in Automatic Answer mode.

- When power is turned on, the teleprinter will be in the Automatic Answer mode. In this mode the telephone will be partially disabled. (No dial tone and no dialing or talking but the ringer can sound) and no printing or data transmission can occur.
- Telephone calls received in the Automatic Answer mode will be answered automatically after one ring on the telephone and the AUTO ANSW key will turn off.

Note: The handset must be on-hook to answer the call.

- Following the ring, the teleprinter will automatically transfer to the Data mode only after the remote originating station transfers to the Data mode.
- The Automatic Answer mode can also be entered:
 - Automatically — following calls in the Data mode. (See Page 15 and 16 for Data mode.)
 - Automatically — following a flashing DATA key when a call is not completed.

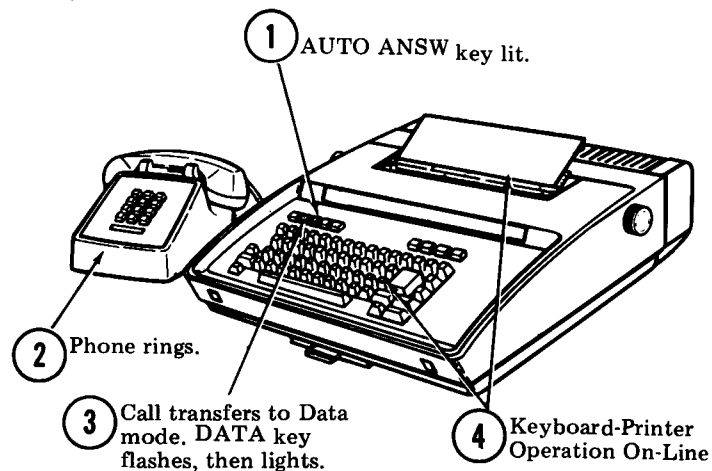

- Depressing AUTO ANSW key momentarily after local operation or talking on the phone. (See Page 14 for Local Talk mode.) If depressed during Data mode the call will disconnect.
- The Automatic Answer mode can also be terminated by:
 - Manual transfer to Local Talk mode.
 - Opening the cover.
 - Operating local printer test.
 - Removing paper.
 - Turning off power.

(Arrangements With No Directly Connected Telephone)



Key lights indicating Terminal Ready mode.

- When power is turned on, the TERM READY lamp will light indicating a standby condition during which calls may be originated or answered.
- When calls are complete and data communication is established as indicated by the DATA lamp lighting, the TERM READY lamp turns off.

- The Terminal Ready mode can also be terminated by:

- Manual transfer to Local Talk mode.
- Opening the cover.
- Operating local printer test.
- Removing paper.
- Turning off power.

- The Terminal Ready mode can be entered by depressing the TERM READY key momentarily. If depressed during the Data mode, a telephone call may disconnect or DATA lamp may extinguish.
- On private line arrangements, the TERM READY lamp lights only when the terminal is ready but the remote terminal or external data set is not ready.

TRANSFER TO TALK

(Arrangements With a Directly Connected Modular Telephone)

Calls can be transferred from the Data mode to the Talk mode. (See Page 5 for transfer back to the Data mode.)

To transfer to the Talk mode, lift the handset and depress the LOCAL TALK key at each station.

Note: If the LOCAL TALK keys are not depressed within 4 seconds of each other a possible disconnect or transfer to the Automatic Answer mode may occur. This can be avoided by prearranged "go to talk" signals that should be exchanged before the transfer is initiated.

(Arrangements With No Directly Connected Telephone)

Call transfer to Talk from the Data mode is under the control of external data communications devices and any associated telephone. Transferring to the Local mode may cause a disconnect. Normally, however, the external communications device will cause the DATA lamp to extinguish and the TERM READY to light when transfer to Talk is initiated.

DISCONNECTING TELEPHONE CALLS

- Telephone calls in the Local Talk mode will be disconnected when the handset is placed on-hook.
- Transfer to Automatic Answer from the Local Talk mode or incomplete transfer to Data (after 20 seconds) will also disconnect the call.
- Telephone calls in the Data mode may be disconnected when:
 - An EOT is received.
 - Manual transfer to Automatic Answer.
 - Transfer to Local Talk mode (disconnects after 4 seconds if handset is on-hook).
 - Eight line feeds received on-line after the ALARM key lights due to a paper-out condition (sprocket and tractor feed only).
 - The printer test is initiated.

INTERRUPT AND ALARM KEYS



Key lights when transmission has been interrupted by the remote station.

Note: The use of this key is system dependent. It may not be operable with some remote stations. When operable, its use should be under direction of the system.

- The INTRPT key operates as follows:

- It lights under control of the remote station. When lit, keyboard sending is disabled.
- If depressed momentarily when lit, the interrupt is canceled.
- If depressed when not lit, the remote station sending may be interrupted ie, stop sending. Locally bell rings and key lights momentarily.

- Interrupt is also canceled by a disconnect or when power is turned off.



Key lights or flashes when alarm condition exists.

- Lights when:

- Paper-out condition is sensed (sprocket and tractor feed). This is an advance warning that eight received line feeds later (in the Data mode),

the call will disconnect. Also, after thirteen line feeds, paper will be out at the print head.

- Low paper condition is sensed (friction feed). This is an advance warning that 25 to 50 feet of paper remain on the paper roll.

- When the cover is opened.

- When printer test is operated.

- Flashes when:

- Teleprinter is in a Loopback Test mode.

- Can be cleared by:

- Replacing paper or closing cover.

- On friction feed printers, if a partially full paper roll is installed, it may be necessary to depress the RESET key on the paper roll support. See Page 12.

- When flashing by:

ESC = sequence.

Depressing LOCAL TALK key.

Turning off power.

Note: In some systems, the ALARM key may be flashing during normal operation accompanied by printing. Unless otherwise instructed, the Alarm should be cleared after extended periods of flashing. See Page 22.

PRINTER TEST, PARITY, DUPLEX AND CHARACTER SPEED KEYS



An independent test of the printer is provided for use by attendant or field service personnel. Test consists of continuous printing of the 94 character printed set as shown below. During test, bell rings and automatic return of carriage and line feed is performed within margin restraints.† Test should not be performed in Data mode since Data mode will be terminated and a telephone call will be disconnected. Depression of PRINTER TEST key initiates test. Test is terminated when this key is released. (See Pages 14 through 18 and 20 for keys that light or extinguish during test.)

Sample of Test Message

```

! " # $ % & ' ( ) * + , - . / 0 1 2 3 4 5 6 7 8 9 ; < = > ? @ A B C D E F G H I J K L M N O P Q R S T U V W X Y Z [ \ ] ^ _ ` a b c d e f g h i j k l m n o p q r s t u v w x y z { | } ~
! " # $ % & ' ( ) * + , - . / 0 1 2 3 4 5 6 7 8 9 ; < = > ? @ A B C D E F G H I J K L M N O P Q R S T U V W X Y Z [ \ ] ^ _ ` a b c d e f g h i j k l m n o p q r s t u v w x y z { | } ~
    0                               0
    ↑                               ↑
    ← Line Length 72 — Option 432b.*
    ← Line Length 80 — Option 432c.*
    ↑                               ↑
    ← Option 431b.*
    ← Option 431c.*
    As Factory
    Furnished
    
```



The proper position of this key depends on system application. The remote sender may or may not be equipped to send correct (even) parity. The 43 Teleprinter sends even parity as factory furnished, Option 434a. When PARITY key is on, characters received with incorrect (odd) parity will print as substitute character symbol ■, when parity is off, the character that is received will be printed or performed if it is a printable character or a valid function. The PARITY key alternately locks down (DN) for parity off or releases up for parity ON to set parity checking mode.

† If margins are set for less than 96 characters, a character will be skipped (not printed) each time a new line starts except for the new line that starts a new cycle of printing.

* See backside of directory card for record of any option exceptions that may have been enabled. Right margin must be set on tractor feed sets using narrow paper.



Half-Duplex (key up) — printer copies data sent and received. The printer can be blinded to on-line transmission from the local keyboard while receiving messages simultaneously from the remote sender. This mode is known as Full Duplex (key down — DN).

Note: The local CR-LF function will not be performed in Full Duplex.

In Half-Duplex, the printer copies all data sent and received but only one sender can operate at a time without interference, ie, characters from the keyboard will be inhibited if the unit is receiving on-line. The key locks down or releases up.



In order to communicate in the Date mode, the transmission rates of the sending and receiving stations must be the same. This key alternately locks down or releases up and sets the on-line operating speed of the station to either 30 (key up) or 10 (key down — DN) characters per second (300 or 100 words per minute).

SPECIAL KEYBOARD CHARACTERS

- Codes for the following characters are generated from the 43 Teleprinter keyboard by use of the CTRL key and the key with the symbol shown, operated together.

These characters are not functional in the Model 43 Teleprinter but may be used in some systems.

DC1	EM	GS	VT	SYN
ETB	NAK	SOH	FF	STX
ENQ	HT	DC3	US	SO
DC2	SI	ACK	CAN	FS
DC4	DLE	RS	ETX	NUL

- The special escape sequences listed below (in addition to those on Page 4) are functional in the 43 Teleprinter by sending (or receiving) the character immediately following the escape character (ESC key).

Use of other escape sequences are system dependent. (Some characters following ESC may print on tractor feed sets.)

ESC > Analog Loop-Back
ESC < Digital Loop-Back §
ESC = Clears either Loop-Back
ESC w Returns carriage and
paper advances one line.

Completely functional only on arrangements with a directly connected modular telephone. Alarm lamp may still flash.

§ Used under control of remote station.

- Repeat speed varies depending on 10, 30 cps on line and approximately 50 cps locally.

KEY TELEPHONES AND EXTENSIONS

- The modular telephone directly connected to the 43 Teleprinter is used in accordance with the originating answering and disconnecting procedures on Pages 6 and 19. In these arrangements other phones cannot be used to originate data calls. The phone may be or have an extension and therefore would be subject to the limitations of extension telephones, for example:
 - Lifting handset, dialing or talking on an extension can interfere with data transmission.
 - Calls may not be disconnected if the extension is off-hook.
- In some cases, the modular phone may be a “designated” extension of a key telephone set. These extensions may be arranged (by use of an exclusion feature) to prevent interference from other phones. The installer should indicate the presence of any extension phones on the directory card.
- Key telephones may be associated with external data sets connected to the terminal. Use of these phones to originate and answer talk and data calls are under the control of the data set and should be specified locally.

WHEN TROUBLE OCCURS

Trouble that is encountered with the terminal should be reported as locally specified. A number to be called in case of trouble may be entered on the directory card pullout by the installer.

If it can be determined that the trouble is in the remote equipment, the attendant at the location in trouble should follow local procedures for that area.

The following table of analysis questions is arranged to aid in the isolation of a trouble for:

- Local correction.
- Correction at the remote location.
- Advising service personnel of Analysis Question results in advance of trouble visit.

Before reporting a trouble, follow the Analysis Questions in the table always starting with Question no. 1 and then proceed according to the "Yes" or "No" directive on the following pages.

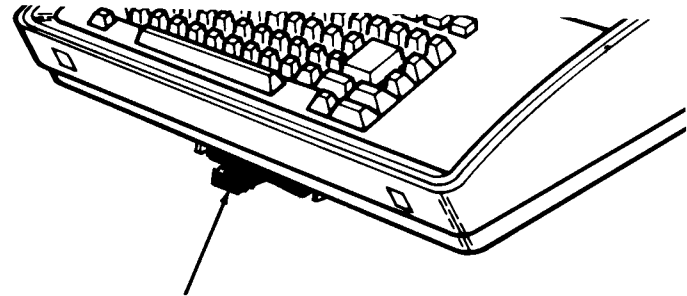

PULLOUT DIRECTORY
CARD FOR TROUBLE NUMBER

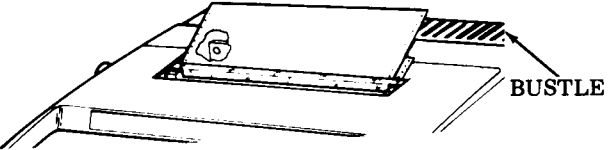
ANALYSIS QUESTION	YES	NO
<p>1. Are one of the three communication mode keys lit? LOCAL or LOCAL-TALK DATA TERM READY or AUTO ANSW</p>	Go to 2.	<ol style="list-style-type: none"> 1. Check that power switch is on. 2. Check that power cord is connected. 3. Check source of power. (Wall switch, other equipment OK, circuit breaker, etc). 4. Report as local trouble in equipment.
<p>2. Does test message print properly while the PRINTER TEST key is depressed? See Page 21</p>	Go to 4.	Go to 3.
<p>3. Is red lamp on power supply lit? (Visible through slot in bustle 6th slot from the left).</p> 	Report as local trouble in printer.	Report as local trouble in power supply.
<p>4. Does printer respond properly to keyboard operation? (Local-Talk mode)</p>	<p>Go to 5 on terminals with a directly connected telephone. Go to 11 for other arrangements.</p>	Report as local trouble in keyboard.

ANALYSIS QUESTION	YES	NO
5. Does printer respond properly to keyboard operation in Analog Loop-Back mode? (ie, print double in half-duplex.) (Entered from keyboard in Local Talk mode by ESC > sequence, ended by ESC =.) (Depress DATA key to light, ALARM key flashes.)	Go to 6.	Report as local trouble in "modem".
6. Does telephone operate normally in the Local Talk mode? (Dial tone, dialing, ringing, talk)	Go to 8.	<ol style="list-style-type: none"> 1. Check that modular cords are connected at rear of teleprinter and phone. 2. Go to 7.
7. Does telephone operate normally when connected directly to line? (ie, modular cord from line connected to phone)	Report as local trouble in teleprinter.	Report as local trouble in telephone.
8. Does phone ring repeatedly in Automatic Answer mode? (ALARM key not lit.)	Report as on-line trouble in teleprinter.	Go to 9.
9. Does DATA key light following call in Automatic Answer or when DATA key is depressed after originating call? (Connection established.)	Go to 11.	<ol style="list-style-type: none"> 1. Remote station must also go to Data mode. 2. Check that modular cords are not reversed, ie, top cord should go to phone. 3. If key does not flash or light, report as trouble in teleprinter. 4. Go to 10.

ANALYSIS QUESTION	YES	NO
10. Is proper tone heard in handset? (High tone if remote party answered the call automatically or transferred to data.)	Report as on-line trouble in teleprinter. (Call does not transfer to Data mode.)	Trouble may be in remote station. (Call does not transfer to Data.)
11. Are data messages properly sent and received in the Data mode?	Go to 12.	<ol style="list-style-type: none"> 1. Check proper speed, DUPLEX and PARITY key positions. 2. Check that INTRPT key is off. 3. Report as on-line trouble in teleprinter unless trouble occurs with only one other station.
12. Is trouble present but not isolated by Questions 1 through 11?	Report other troubles as specified in local instructions.	

Teletype Corporation Product Service and Education Services

On the following page is a list of Teletype Corporation Product Service locations which provide maintenance service and repair on all Teletype Corporation products. For more information call toll free (US 800-323-4226) (IL 800-942-4192) 7:00 A.M. — 4:00 P.M. CST.

In addition, Teletype Corporation provides customer technical training at its headquarters at 5555 W. Touhy Avenue, Skokie, IL in the northwest suburban area of Chicago. The training covers the installation, maintenance and repair of all Teletype Corporation products. Arrangements can also be made for training to be conducted at customer-selected field sites.

For information about class schedules, enrollment, tuition, on-site training or any special training needs, please contact:

Education Services
Teletype Corporation
5555 W. Touhy Avenue
Skokie, Illinois 60077
Telephone (312) 982-3940
TLX 25-4051
TWX 901-223-3611

SERVICE CENTERS

ALABAMA	BIRMINGHAM	230 OXMOOR CIRCLE SUITE 1113, HOMEWOOD, AL 35209	(205) 942-2574
	MOBILE	3207 INTERNATIONAL DR., SUITE B, MOBILE, AL 36606	(205) 473-8888
ARIZONA	PHOENIX	2113 S. 48TH ST., SUITE 104, TEMPE, AZ 85282	(602) 894-9891
	TUCSON	2015 N. FORBES BLVD., TUCSON, AZ 85705	(602) 623-6419
ARKANSAS	LITTLE ROCK	7501 INTERSTATE 30, SUITE 43, LITTLE ROCK, AR 72209	(501) 562-0266
CALIFORNIA	▲ LOS ANGELES	5445 SHEILA, CITY OF COMMERCE, CA 90040	(213) 726-2222
	OAKLAND	7305 EDGEWATER, SUITE C, OAKLAND, CA 94621	(415) 430-0202
	ORANGE COUNTY	11552 KNOTT, SUITE 9, GARDEN GROVE, CA 92641	(714) 891-2628
	SACRAMENTO	4221 NORTHGATE BLVD. NO. 4, SACRAMENTO, CA 95834	(916) 924-1933
	SAN DIEGO	7283 ENGINEER RD., SUITE B, SAN DIEGO, CA 92111	(714) 565-4375
	SANTA CLARA	3285 KIFER RD., SANTA CLARA, CA 95051	(408) 730-9083
	VENTURA COUNTY	2696 LAVERY COURT, SUITE 1, NEWBURY PARK, CA 91320	(805) 498-9655
COLORADO	COLORADO SPRINGS	905 GARDEN OF THE GODS RD., SUITE B, COLORADO SPRINGS, CO 80907	(303) 593-1222
	▲ DENVER	7100 BROADWAY, BUILDING 3-J, DENVER, CO 80221	(303) 429-9555
CONNECTICUT	HARTFORD	441 GOVERNORS HWY., SOUTH WINDSOR, CT 06074	(203) 568-9610
DIST. OF COLUMBIA	▲ LORTON, VA	9022 TELEGRAPH RD., LORTON, VA 22079	(703) 550-7507
FLORIDA	FT. LAUDERDALE	6858 N.W. 20TH AVE., FT. LAUDERDALE, FL 33309	(305) 974-4660
	JACKSONVILLE	6002 BOWDENDALE AVE., JACKSONVILLE, FL 32216	(904) 739-1170
	MIAMI	12802 S.W. 122ND AVE., MIAMI, FL 33186	(305) 252-1370
	ORLANDO	102 LIVE OAKS BLVD., CASSELBERRY, FL 32707	(305) 834-3818
	TAMPA	5474 JETPORT INDUSTRIAL BLVD., TAMPA, FL 33614	(813) 885-7413
GEORGIA	▲ ATLANTA	2520 PARK CENTRAL BLVD., DECATUR, GA 30035	(404) 981-7267
IDAHO	BOISE	172 S. COLE RD., BOISE, ID 83709	(208) 343-3629
ILLINOIS	▲ CHICAGO NORTH	2330 EASTERN AVE., ELK GROVE VILLAGE, IL 60007	(312) 860-5602
	▲ CHICAGO SOUTH	2900 21ST AVE., BROADVIEW, IL 60153	(312) 345-7920
	DECATUR	3501 RUPP PKWY., DECATUR, IL 62526	(217) 875-1092
INDIANA	INDIANAPOLIS	6240 LAS PAS TRAIL, INDIANAPOLIS, IN 46268	(317) 255-4566
IOWA	DES MOINES	8345 UNIVERSITY BLVD., DES MOINES, IA 50311	(515) 223-8444
KANSAS	KANSAS CITY	6339 W. 110TH ST., OVERLAND PARK, KS 66211	(913) 383-3370
KENTUCKY	LOUISVILLE	3600 CHAMBERLAIN, SUITE 348, LOUISVILLE, KY 40222	(502) 426-4312
LOUISIANA	NEW ORLEANS	5626 JEFFERSON HWY., HARAHAN, LA 70123	(504) 733-4823
	SHREVEPORT	5150 INTERSTATE P.O. 9128, SHREVEPORT, LA 71109	(318) 636-7104
MARYLAND	BALTIMORE	8980 ROUTE 108, COLUMBIA, MD 21045	(301) 796-1166
MASSACHUSETTS	BOSTON	131 FLANDERS RD., P.O. BOX 566, WESTBORO, MA 01581	(617) 366-8881
MICHIGAN	DETROIT	12916 FARMINGTON RD., LIVONIA, MI 48150	(313) 525-5356
	KALAMAZOO	126 E. KILGORE RD., KALAMAZOO, MI 49001	(616) 344-1944
	LANSING	3202 S. PENNSYLVANIA AVE., LANSING, MI 48910	(517) 394-6250
MINNESOTA	DULUTH	HWY 61 & CANOSIA RD., ESKO, MN 55733	(218) 879-1225
	MINNEAPOLIS	8824 SEVENTH AVE., NO., GOLDEN VALLEY, MN 55427	(612) 546-0808
MISSISSIPPI	JACKSON	137 TURN-POWE PLAZA, PEARL, MS 39208	(601) 932-1273
MISSOURI	ST. LOUIS	117766 WESTLINE INDUSTRIAL DR., ST. LOUIS, MO 63141	(314) 567-5910
NEBRASKA	OMAHA	13415 B STREET BAY 2, OMAHA, NE 68144	(402) 330-3606
NEVADA	RENO	23 GLEN-CARRAN CIRCLE, SPARKS, NV 89431	(702) 356-8022

NEW JERSEY	▲ FAIRFIELD	90 CLINTON ROAD, FAIRFIELD, NJ 07006	(201) 575-8240
	EDISON	1245 ROUTE 1, EDISON, NJ 08817	(201) 494-8288
NEW MEXICO	ALBUQUERQUE	2820 BROADBENT PKWY., N.E., ALBUQUERQUE, NM 87107	(505) 345-1854
NEW YORK	ALBANY	4 NORMANSKILL BLVD., ELSMERE, NY 12054	(518) 462-9937
	BUFFALO	1505 CLEVELAND DR., CHEEKTOWAGA, NY 14225	(716) 634-7233
	LONG ISLAND	195 PARK AVENUE, BETHPAGE, NY 11714	(516) 822-3533
	MANHATTAN	42 BROADWAY, SUITE 1633, NEW YORK, NY 10004	(212) 785-2530
	ROCHESTER	115 METRO PARK, ROCHESTER, NY 14623	(716) 475-1740
	SYRACUSE	5 ADLER DR., EAST SYRACUSE, NY 13057	(315) 463-4666
NORTH CAROLINA	CHARLOTTE	11190 DOWNS RD., PINEVILLE, NC 28134	(704) 588-3297
	DURHAM	500 E. WILLIAMS ST., APEX, NC 27502	(919) 362-4469
	GREENSBORO	727 E. MOUNTAIN ST., KERNERSVILLE, NC 27284	(919) 996-4934
	CINCINNATI	4890 DUFF DR., SUITE E, CINCINNATI, OH 45246	(513) 874-2586
OHIO	CLEVELAND	5325 NAIMAN PKWY, SUITE F, SOLON, OH 44139	(216) 248-0288
	COLUMBUS	6969 WORTHINGTON, GALENA RD., WORTHINGTON, OH 43085	(614) 436-2065
	TOLEDO	1000 S. REYNOLDS RD., TOLEDO, OH 43615	(419) 381-9900
OKLAHOMA	OKLAHOMA CITY	1000 CORNELL PKWY., SUITE 700, OKLAHOMA CITY, OK 73108	(405) 947-0969
	TULSA	2002 S. 114TH EAST AVE., TULSA, OK 74128	(918) 437-2010
OREGON	PORTLAND	7950 S. W. CIRrus DR., BEAVERTON, OR 97005	(503) 641-9575
PENNSYLVANIA	HARRISBURG	4407-D CARLISLE PIKE, CAMPHILL, PA 17011	(717) 737-0405
	PHILADELPHIA	103 ROCK ROAD, HORSHAM, PA 19044	(215) 674-2181
	PITTSBURGH	780 PINE VALLEY DR., PITTSBURGH, PA 15239	(412) 325-4403
SOUTH CAROLINA	COLUMBIA	6007 TWO NOTCH RD., COLUMBIA, SC 29204	(803) 786-2927
TENNESSEE	MEMPHIS	1835 NONCONNAH BLVD., SUITE 121, MEMPHIS, TN 38132	(901) 346-8840
	NASHVILLE	220 GREAT CIRCLE RD., SUITE 134, NASHVILLE, TN 37228	(615) 254-0546
TEXAS	▲ DALLAS	222 N. STORY RD., SUITE 126, IRVING, TX 75061	(214) 254-4189
	HOUSTON	8981 INTERCHANGE DRIVE, HOUSTON, TX 77054	(713) 666-1671
	SAN ANTONIO	4243 CENTER GATE, SAN ANTONIO, TX 78217	(512) 656-9370
	SALT LAKE CITY	3650 W. 2100 SOUTH, SALT LAKE CITY, UT 84120	(801) 972-6332
UTAH	LORTON (DC AREA)	5701-G GENERAL WASHINGTON DR., ALEXANDRIA, VA 22312	(703) 941-6202
VIRGINIA	NORFOLK	5308-D VIRGINIA BEACH BLVD., NORFOLK, VA 23502	(804) 461-1778
	RICHMOND	8427 GLAZEBROOK AVE., RICHMOND, VA 23228	(804) 262-4062
	SEATTLE	635 STRANDER BLVD., SEATTLE, WA 98188	(206) 575-4515
WASHINGTON	CHARLESTON	808 MAIN STREET, NITRO, WV 25143	(304) 755-3300
WEST VIRGINIA	APPLETON	324 W. WISCONSIN AVE., SUITE 3, APPLETON, WI 54911	(414) 731-1494
WISCONSIN	EAU CLAIRE	1806 WARDEN ST., EAU CLAIRE, WI 54701	(715) 832-4431
	MADISON	3680 KINSMAN BLVD., MADISON, WI 53704	(608) 249-5999
	MILWAUKEE	448 W. RAWSON AVE., OAK CREEK, WI 53154	(414) 764-6500
	WAUSAU	120 E. STEWART AVE., WAUSAU, WI 54401	(715) 845-8688
CANADA	▲ TORONTO	31 KLONDIKE DR., WESTON, ONTARIO, CANADA M9L 1S1	(416) 745-9474

▲ REGIONAL OFFICES



TELETYPE CORPORATION
5555 Touhy Avenue, Skokie, Illinois 60077
Telephone: (312) 982-2000

HOW TO OPERATE MANUAL 367
Issue 6, March 1982



TELETYPE CORPORATION
5555 Touhy Avenue, Skokie, Illinois 60077
Telephone: (312) 982-2000

HOW TO OPERATE MANUAL 367
Issue 6, March 1982