

## Multi-Technology Ceiling Mounted Occupancy Sensor

Cat. No. OSC05-M, OSC10-M, OSC20-M

To be used with 24VDC OSPxx Series and CN100 Power Pack Class II Low-Voltage Wiring

### INSTALLATION INSTRUCTIONS

#### WARNINGS AND CAUTIONS:

- To be installed and/or used in accordance with appropriate electrical codes and regulations.
- If you are unsure about any part of these instructions, consult a qualified electrician.
- Sensors must be mounted on a vibration free surface.
- All sensors must be mounted at least 6 feet away from air vents.
- Do not mount sensors closer than 10 feet from each other.
- Do not touch the surface of the lens. Clean outer surface with a damp cloth only.

CATALOG ITEMS					
Catalog No.	Description	Current Consumption	Operating Frequency	Coverage	Suggested Mounting Location
OSC05-M0W	1-Way Multi-Technology	30mA	40KHz	500 sq. ft.	Mounts in corner/over doorway
OSC10-M0W	2-Way Multi-Technology	40mA	40KHz	1000 sq. ft.	Mount in center of room/area
OSC20-M0W	2-Way Multi-Technology	32mA	32KHz	2000 sq. ft.	Mount in center of room/area

#### FCC COMPLIANCE STATEMENT:

This device complies with part 15 and part 18 of the FCC rules. Operation is subject to the following two conditions: (1) This device must not cause harmful interference, and (2) This device must accept any interference received, including interference that may cause undesired operation.

#### Tools needed to install your Sensor:

Slotted/Phillips Screwdriver  
Pliers  
Cutters

Electrical Tape  
Pencil

#### Parts Included List:

Sensor (1)  
#8-32 x 1/2" Screw (2)  
#8-32 x 1-1/2" Screw (2)  
#8-32 Washer and Nut (2)

Threaded Rod (1) and Hex Nut (1)  
Half Mask (1)  
360° Perforated Mask (1)  
Plastic Washer (1)

#### DESCRIPTION

The Occupancy Sensor is a low-voltage infrared and ultrasonic sensor that works with the OSPxx Series and CN100 power pack to automatically control lighting. The sensor turns the lights on and keeps them on whenever occupancy is detected and will turn them off after the 'delayed-off time' has expired.

The sensor continually analyzes and adjusts to changing conditions. The sensor uses the latest microprocessor-based technology which permits it to continually adjust and optimize its performance.

The combination of ultrasonic (doppler shift) motion detection which gives maximum sensitivity and infrared motion detection which gives higher false triggering immunity yields a sensor with excellent performance.

#### INSTALLING YOUR OCCUPANCY SENSOR

NOTE: Use check boxes  when Steps are completed.

**Step 1** WARNING: TO AVOID FIRE, SHOCK, OR DEATH; TURN OFF POWER at circuit breaker or fuse and test that power is off before wiring!

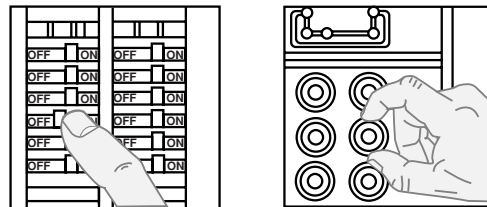

#### Step 2 Preparing and connecting wires:

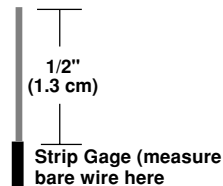
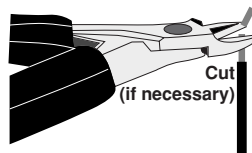

#### Step 3 Typical Installations:

Listed are 3 typical installation options (A, B, and C). Choose one that best suits your needs. Other methods of installation may be possible but they have not been described here.

##### A. Drop Ceiling Installation (Mounting Option A):

NOTE: Use the threaded rod included.

- Select location for mounting of sensor and proper masking for your application (refer to Mounting Location Diagram).
- Use the supplied threaded rod or other methods to make a hole (1/2" to 1") in the ceiling tile just large enough to pass the body of the threaded rod through.
- Insert the sensor wires through the flared end of the threaded rod. Position the threaded rod to the base of the sensor.
- Insert the flared end of the threaded rod into the opening in the bottom of the sensor and twist to lock into place.

#### Step 3 cont'd

- Push the wires into the hole in the ceiling tile and insert the threaded rod until the sensor is flush with the tile.
- Insert wires through the hole in the included washer, then place the included washer over the rod and screw on the included hex nut.
- Class II Wiring:** Connect low-voltage wires from Power Pack to Sensor per WIRING DIAGRAM as follows: Twist strands of each lead tightly and, with circuit conductors, push firmly into appropriate wire connector. Screw connectors on clockwise making sure that no bare conductor shows below the wire connectors. Secure each connector with electrical tape.
- Rotate the sensor to the desired orientation. Note that the sensor base and back cover are keyed. To lock the device in place, ensure that the arrows are not aligned.
- Restore power at circuit breaker or fuse to Power Pack. **INSTALLATION IS COMPLETE.**

#### Mounting Option Diagram A Occupancy Sensor Mounted to Drop Ceiling Using Threaded Rod

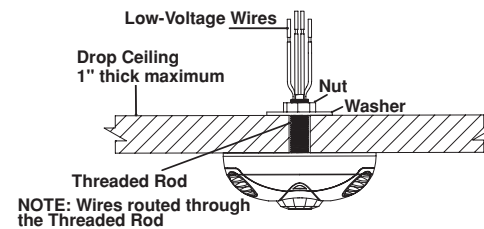

NOTE: Wires routed through the Threaded Rod

##### B. Wallboard or Drop Ceiling Installation (Mounting Option B):

NOTE: You may use the mounting screws, nuts and washers included, or screws in combination with commercially available wall anchors.

- Select location for mounting of sensor and proper masking for your application (refer to Mounting Location Diagram).
- Make a hole in the ceiling tile or wallboard large enough to pass the wire connections and wire nuts through (approximately 1" diameter).
- Remove the back cover of the sensor. Hold the back cover and body of the sensor and rotate until the two arrows line up and pull apart.
- Install back cover of the ceiling sensor to the wallboard or drop ceiling using the included screws, nuts and washers, or screws in combination with commercially available wall anchors.
- Class II Wiring:** Connect low-voltage wires from Power Pack to Sensor per WIRING DIAGRAM as follows: Twist strands of each lead tightly and, with circuit conductors, push firmly into appropriate wire connector. Screw connectors on clockwise making sure that no bare conductor shows below the wire connectors. Secure each connector with electrical tape.
- Push wire connections through the center hole of the back cover and into the ceiling.
- Secure the sensor body to the back cover by aligning the arrows. Lock it by turning the sensor such that the arrows do not line up.
- Rotate the sensor to the desired orientation.
- Restore power at circuit breaker or fuse to Power Pack. **INSTALLATION IS COMPLETE.**

#### Mounting Option Diagram B Occupancy Sensor Mounted to Wallboard or Drop Ceiling Using Screws

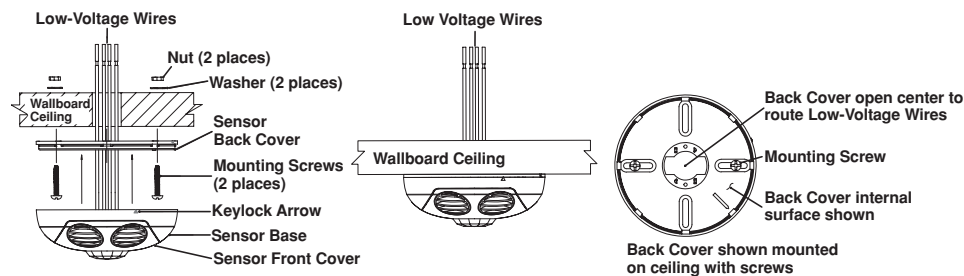

#### Step 3 cont'd

##### C. Junction Box or Surface Mount Raceway Installation (refer to Mounting Diagrams):

NOTE: Listed below are suggested JUNCTION BOX installation applications which require mounting to conduit in one of the following three ways:

##### Occupancy Sensor Mounted to Octagon Box Installed Flush to Wallboard Ceiling

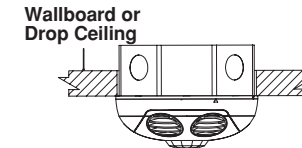
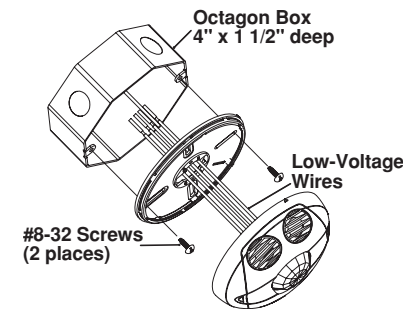

#### Step 3 cont'd

##### Occupancy Sensor Mounted to Round Fixture with Raceway for Wallboard Installation

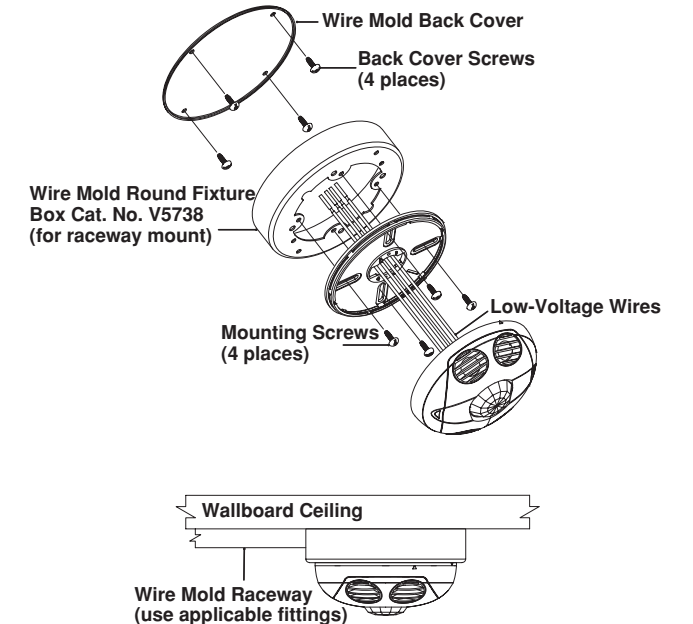

#### Wiring Diagram: Multiple Sensor, Single Power Pack

TABLE 2: WIRE DESIGNATIONS			
Name	Color	Gauge	Temp/Voltage
Power (+24V)	Red	24	200° C/ 600V
DC Return	Black	24	200° C/ 600V
Occupancy	Blue	24	200° C/ 600V
Occupancy/Photocell	Gray	24	200° C/ 600V

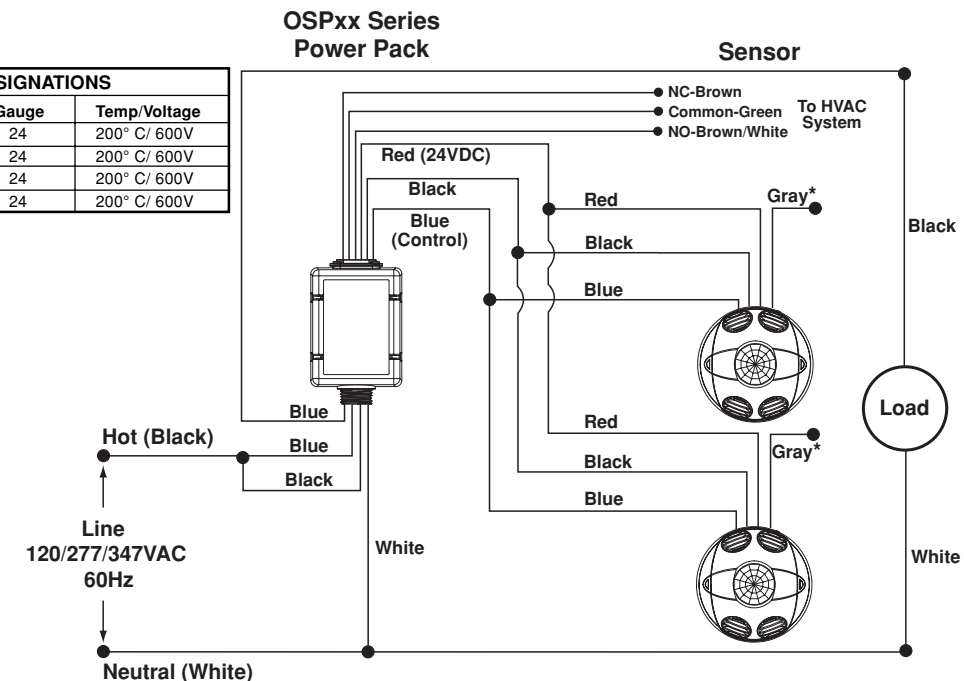

\*NOTE: When using the Photocell function, connect the Gray wire of the sensor to the Blue wire of the power pack. **DO NOT** use the Blue wire of sensor.

NOTE: Ensure to cap wire that is not being used.

## OPERATION

- Multi-Tech Mode** – This is the default mode of operation for the sensor. PIR technology turns lights on in this mode; however, motion detection by either technology will keep the lights on. If neither technology detects motion, the lights turn off after the delayed-off time.
- Single-Tech Mode** – Only one technology is active in this mode. The technology is selected by the dip switches. Motion detection by the selected technology - PIR or ultrasonic - will turn on the lights as well as keep them on. When motion is not detected, the lights will turn off after the delayed-off time.
- Delayed-Off time** – The sensor is designed to turn the lights off if no motion is detected after a specified time. This length of time is called the delayed-off time and is set using the timer (Black) knob on the sensor. The adapting patterns will modify the delayed-off time to fit the parameters of each installation based on environmental conditions and occupancy patterns.
- Walk-through Mode** – The walk-through feature is useful when a room is momentarily occupied. With this feature, the sensor will turn the lights off shortly after the person leaves the room.  
The walk-through feature works as follows: When a person enters the room, the lights will turn on. If the person leaves the room before the default walk-through time-out of 2.5 minutes, the sensor will turn the lights off. If the person stays in the room for longer than 2.5 minutes, the sensor will proceed to the standard operation.
- LED Operation** – There are two LED indicators that will flash when motion is detected. The LED flash can be disabled using the LED disable switch setting. Green flash indicates motion detection by ultrasonic technology. Red flash indicates motion detection by infrared technology.

## ADAPTIVE FUNCTIONS

The Sensor continually analyzes the parameters of the motion detection signal and adjusts its internal operation to maximize detection of motion while minimizing the effects of noise (electrical noise, air currents, temperature changes, etc...).

### Operation:

When the lights turn on, the sensor initially enters the "walk-through" mode. Once the room is occupied for longer than 2.5 minutes, the sensor exits the "walk-through" mode and enters the "Occupied" mode. When the sensor is first installed, the delayed-off time for the occupied mode is based on the Time adjustment settings. While the sensor is in use, the delayed-off time will change, based on how the sensor adapts to the room conditions. Whenever the sensor subsequently turns on, the value of the delayed-off time will be the *adapted* value (refer to **Occupancy Pattern Learning For Delayed Off Time**).

The adapted settings can be reset using the DIP switch.

### Occupancy Pattern Learning For Delayed Off Time:

The sensor will automatically change the delayed off time in response to the occupancy and environmental conditions of the space it is installed in. The sensor analyzes the motion signal properties and will minimize the delayed off time duration when there is frequent motion detection, and lengthen the delayed off time duration when there is weak and infrequent motion detection.

In the case of a false-off condition (lights turn off when the room is occupied), the delayed off time duration will immediately be lengthened to prevent further false turn offs.

### Occupancy Pattern Learning for Ultrasonic Technology:

The sensor learns the occupancy patterns of a space during the course of a day, for a seven day period. At any given time, the sensor will look at the collected data and adjust its ultrasonic sensitivity. The sensor will adjust the sensitivity to make it less likely to turn on during a period of non-occupancy and more likely to turn on during a period of occupancy. This adapting feature is not applicable when the sensor is in PIR only mode.

## SETTINGS

### Default Settings:

Adjustment knob settings as per "recommended manual settings," (refer to Table 3 and Figure 1).

All switches in the off position (refer to Table 4).

TABLE 3: ADJUSTMENT KNOB SETTINGS				
Knob Color	Symbol	Function	Knob Setting	Factory Default Setting
Green		Sets the ultrasonic range	Range setting Full CCW = min. (OFF) Full CW = max.	50%
Red		Sets the infrared range	Range setting Full CCW = min. (OFF) Full CW = max.	75%
Black		Delayed- Off Time	Full CCW = min. (30 sec.) Full CW = max. (30 min.)	50% (10 min)
Blue		Ambient Light Override (Gray wire only)	Full CCW – Lights stay OFF Full CW – Lights always turn ON (NO ambient light override) Range – 100-3000 LUX	100%

TABLE 4: SWITCH SETTINGS			
SWITCH	SWITCH FUNCTIONS	SWITCH SETTINGS	
		Bank A	Bank B
A1	Single/Multi-Tech Mode	Multi-Tech	Single Tech
A2*	PIR/Ultrasonic Mode	PIR	Ultrasonic
A3	Manual Mode	Auto Adapting Enabled	Auto Adapting Disabled
A4	Walk-Through Disable	Walk-Through Enable	Walk-Through Disable
<b>Bank B</b>			
B1	Override to ON	Auto Mode	Lights Forced ON
B2	Override to OFF	Auto Mode	Lights Forced OFF
B3	Test Mode	OFF → ON → OFF = Enter/Exit Test Mode	
B4	LEDs Disable	LEDs Enabled	LEDs Disable

\*NOTE: This setting is only used if the Single Technology Option (switch A1) is selected.

**Test Mode:** To set the delayed-off time to 6 seconds for performing a walk test. While the sensor is in test mode, the LED's will flash amber once a second.

- ENSURE POWER IS ON.**
- Remove front cover.
- Locate Dip Switch 3 in Bank B (B3) (refer to Figure 1). B3 will be in the OFF position from the factory.
- To enter Test Mode, move switch to ON and back to OFF. The test mode has now been entered with a 6 second time-out. **NOTE:** If B3 is already in the ON position, then test mode can be entered by just moving it to the OFF position.

### NOTES:

- The timer will remain in the 6 second test mode for 15 minutes, then automatically exit test mode and reset to the delayed-off time setting as defined by the black timer knob.
- To manually take the timer out of the 6 second test mode, simply toggle the switch B3 from OFF to ON and back to OFF.

### Photocell (Ambient Light Override) adjustment:

In order to use the Ambient Light Override functionality of the sensor, the sensor must be wired to the power pack (OSPXX) using the gray wire instead of the blue wire. This feature allows the user to conserve energy by keeping the controlled lights off when not necessary. The sensor does this by measuring the amount of ambient light in the installed area and keeping the controlled lights off if there is enough ambient light available. To use this feature, the Photocell adjustment (blue) knob must be adjusted from the default position. Once this adjustment is made, the controlled lights will only turn on if the ambient light present is less than the setting.

### To set the Photocell level (used with the gray wire connection):

**NOTE:** This setting must be performed when the natural light is low enough to require artificial light.

- Remove the cover from the sensor.
- Make note of the position of the Red and Green knobs. Rotate the Red and Green knobs full CCW and enter the sensor's Test mode as described above.
- Rotate the Blue knob full CCW.
- Wait for the lights to turn OFF.
- Rotate the Red knob full CW.
- Slowly rotate the blue knob clockwise until the lights turn ON. This is the correct setting.
- Return the Red and Green knobs to their original positions.
- Replace cover. Setting is complete.

Figure 1  
Minimum and Default Settings

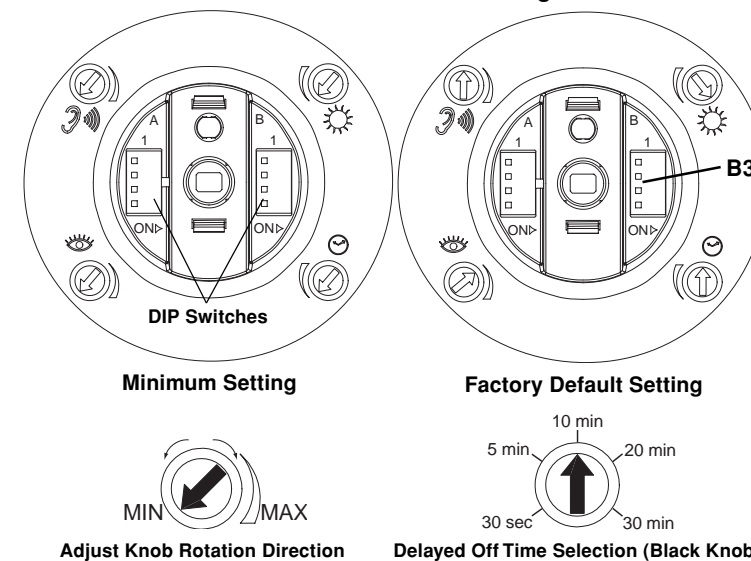

Figure 2 (Cat. No. OSC05)  
Field-of-View Ranges

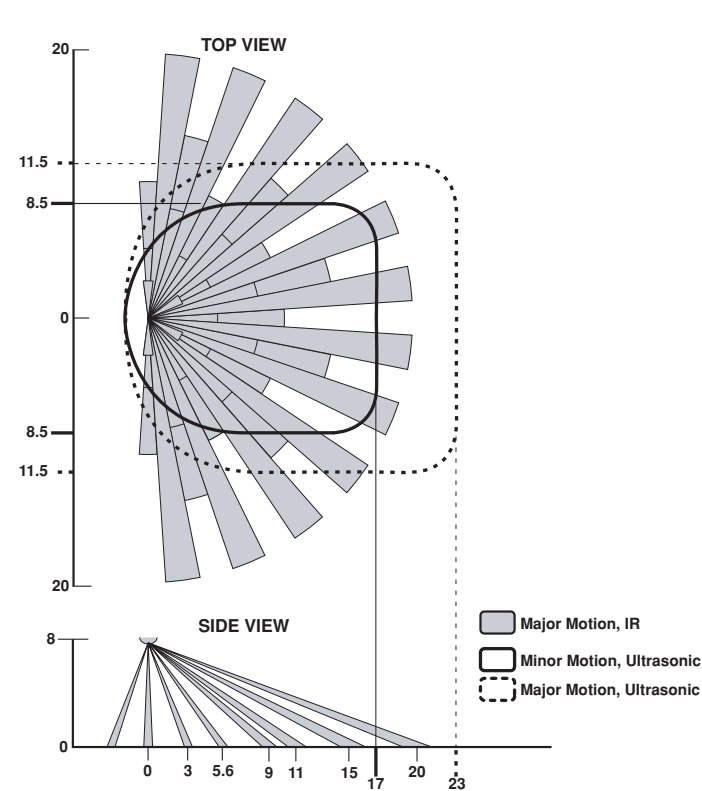

Figure 4 (Cat. No. OSC20)  
Field-of-View Ranges

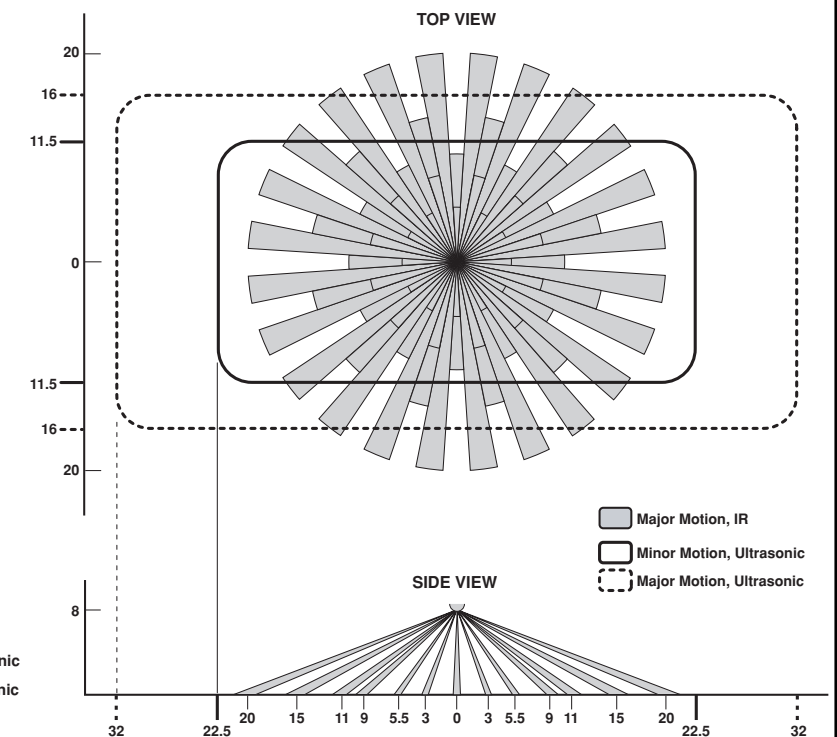
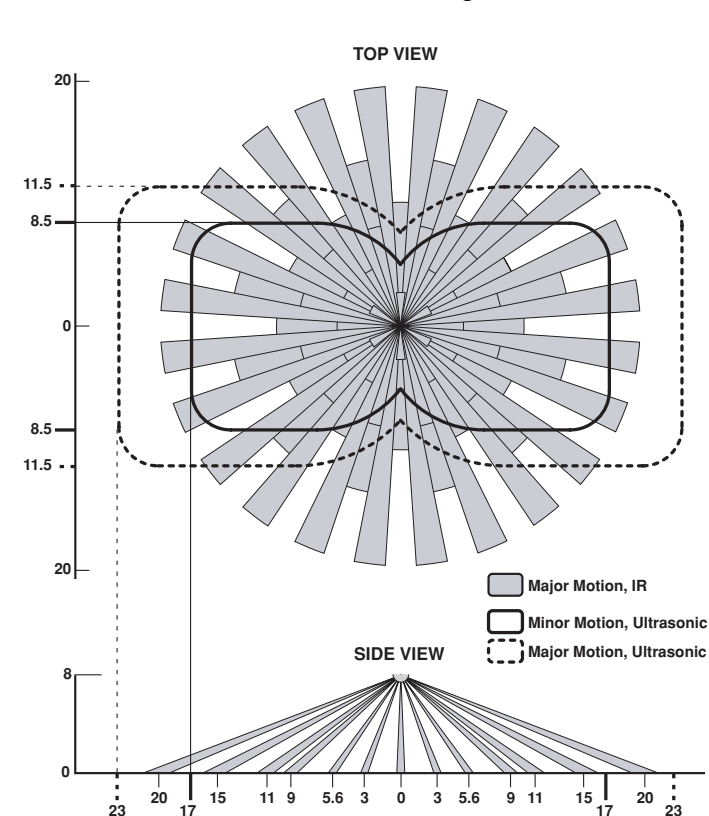
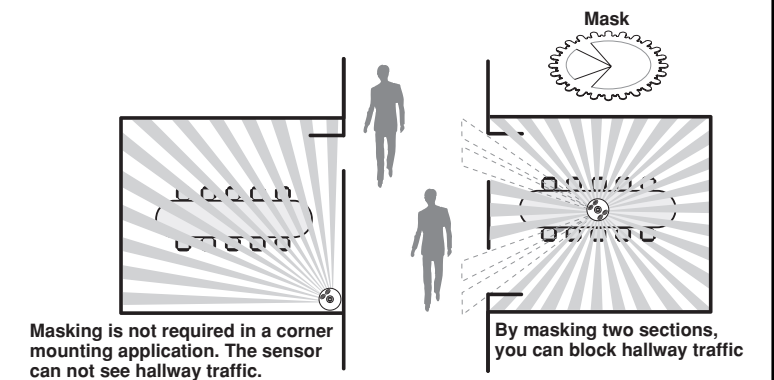

Figure 3 (Cat. No. OSC10)  
Field-of-View Ranges



## Mounting Location Diagram



## TROUBLESHOOTING

- Lights do not turn ON
  - Circuit breaker or fuse has tripped.
  - Low-voltage miswired. **To Test:** Connect RED to BLUE wire at power pack to force lights ON.
  - Line voltage miswired. **To Test:** Connect BLUE to BLUE relay wires (of power pack) to force the lights ON.
- Lights stay ON
  - Constant motion. **To Test:** Reduce RED and/or GREEN knob by 15%; remove motion source. If unsatisfactory, move sensor.
  - Infrared sensor can "see" into hallway. **To Test:** Put sensor in timer test mode walk and walk hallway. If lights continue to come ON, move sensor.
- Light turns ON too long
  - Timer setting too high. **To Test:** Check switch settings. Typical setting is 10 minutes.

## PRODUCT INFORMATION

- For technical assistance, contact us at **1-800-824-3005**
- Visit our website at **www.leviton.com**

## LIMITED 5 YEAR WARRANTY AND EXCLUSIONS

Leviton warrants to the original consumer purchaser and not for the benefit of anyone else that this product at the time of its sale by Leviton is free of defects in materials and workmanship under normal and proper use for five years from the purchase date. Leviton's only obligation is to correct such defects by repair or replacement, at its option, if within such five year period the product is returned prepaid, with proof of purchase date, and a description of the problem to Leviton Manufacturing Co., Inc., Attn: Quality Assurance Department, 59-25 Little Neck Parkway, Little Neck, New York 11362-2591. This warranty excludes and there is disclaimed liability for labor for removal of this product or reinstallation. This warranty is void if this product is installed improperly or in an improper environment, overloaded, misused, opened, abused, or altered in any manner, or is not used under normal operating conditions or not in accordance with any labels or instructions. There are no other or implied warranties of any kind, including merchantability and fitness for a particular purpose, but if any implied warranty is required by the applicable jurisdiction, the duration of any such implied warranty, including merchantability and fitness for a particular purpose, is limited to five years. Leviton is not liable for incidental, indirect, special, or consequential damages, including without limitation, damage to, or loss of use of, any equipment, lost sales or profits or delay or failure to perform this warranty obligation. The remedies provided herein are the exclusive remedies under this warranty, whether based on contract, tort or otherwise.